



Electrolux
PROFESSIONAL

**Modular Cooking Range Line
900XP Freestanding Electric
Boiling Pan 60lt indirect heat**

ITEM # _____

MODEL # _____

NAME # _____

SIS # _____

AIA # _____



391233 (E9BSEHINF0)

60-lt electric Boiling Pan
with pressure switch, indirect
heating

Short Form Specification

Item No. _____

To be installed on cantilever systems but also incorporates fixing points for bridging. Incoloy armoured elements with safety thermostat positioned in the jacket cavity base. Exterior panels of unit in stainless steel with Scotch Brite finish. Pressed well bottom with rounded edges manufactured from AISI 316 stainless steel. Right-angled side edges to allow flush-fitting junction between units. Includes safety valve to control working pressure. Temperature limiter for power regulation allowing precise temperature cooking.

Main Features

- Sides of vessel with satin finishing for easy cleaning.
- All major compartments located in front of unit for ease of maintenance.
- Easy-to-use control panel.
- Unit delivered with four 50 mm legs in stainless steel as standard (all round Stainless steel kick plates as option).
- Water basins are seamlessly welded into the top of the appliance.
- Water basins in 316 type Stainless steel.
- Safety thermostat protects against low water level.
- Continuous water filling regulated through a manual water tap.
- Large drain with manual ball-valve for fast emptying of well.
- Appliance is IPX5 water resistance certified.
- Discharge tube and tap are very easy to clean from outside.
- Ergonomic: the depth of the vessel facilitates stirring the food, also the most delicate food.
- External valve allows to manually evacuate excess air accumulated in the jacket during heating phase.
- Pressed cooking vessel and lid in 316 AISI Stainless steel.
- Large capacity food tap enables safe and effortless discharging of contents.
- Manometer allows to correctly control the functioning of the pan.
- No overshooting of cooking temperatures, fast reaction.
- Produce is uniformly heated in the base and side walls of the kettle by an indirect heating system that uses integrally generated saturated steam at a temperature of 110° C in the jacket.
- Round kettle is suitable to cook, sauté or poach all kinds of produce.
- Safety thermostat to avoid operation without water.
- Safety valve avoids overpressure of the steam in the jacket.
- Solenoid valve to refill with hot and cold water.
- The special design of the control knob system guarantees against water infiltration.
- Energy regulation through a control knob.
- Heavy duty internal frame in Stainless steel.
- Right angled side edges eliminate gaps and possible dirt traps between units.
- Incoloy armoured elements with safety thermostat positioned in the jacket cavity base.
- Minimum load for correct functioning is 20 liters.

APPROVAL: _____



Experience the Excellence
www.electroluxprofessional.com

Construction

- Stainless steel top provides a heavy duty work surface under any load.
- AISI 304 stainless steel worktop, 2mm thick.
- IPx4 water protection.
- Model has right-angled side edges to allow flush fitting joints between units, eliminating gaps and possible dirt traps.
- All exterior panels in Stainless Steel with Scotch Brite finishing.

Sustainability



- Closed heating system - no waste of energy.
- Firmly fitting cover to reduce cooking time and save energy costs.
- Pressure switch control monitors energy and water consumption.

Included Accessories

- 1 of Water additive against corrosion for indirect boiling pans PNC 927222

Optional Accessories

- Junction sealing kit PNC 206086
- Kit 4 wheels - 2 swivelling with brake - it is mandatory to install Base support and wheels PNC 206135
- Flanged feet kit PNC 206136
- Frontal kicking strip for concrete installation, 800mm PNC 206148
- Frontal kicking strip for concrete installation, 1000mm PNC 206150
- Frontal kicking strip for concrete installation, 1200mm PNC 206151
- Frontal kicking strip for concrete installation, 1600mm PNC 206152
- Frontal kicking strip, 800mm (not for refr-freezer base) PNC 206176
- Frontal kicking strip, 1000mm (not for refr-freezer base) PNC 206177
- Frontal kicking strip, 1200mm (not for refr-freezer base) PNC 206178
- Frontal kicking strip, 1600mm (not for refr-freezer base) PNC 206179
- Pair of side kicking strips (not for refr-freezer base) PNC 206180
- 2 panels for service duct for single installation PNC 206181
- 2 panels for service duct for back to back installation PNC 206202
- Kit 4 feet for concrete installation (not for 900 line free standing grill) PNC 206210
- Chimney upstand, 800mm PNC 206304
- Base support for feet or wheels - 800mm (700/900) PNC 206367
- 2 side covering panels for free standing appliances PNC 216134
- 1-section noodle basket for 60lt boiling pans PNC 921626
- Measuring rod for 60 l Boiling Pan PNC 927000
- Water additive against corrosion for indirect boiling pans PNC 927222

Front

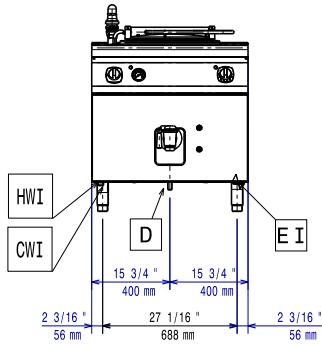

Side

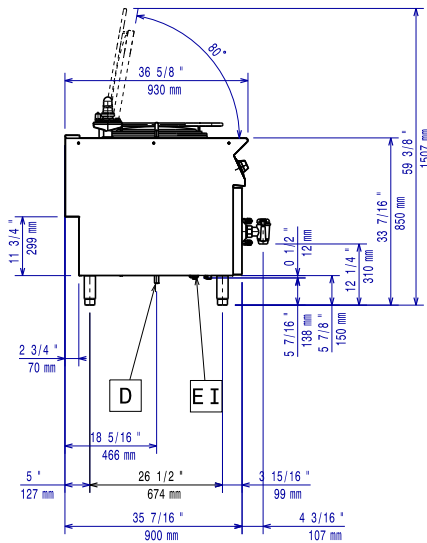

- CWI = Cold Water inlet 1 (cleaning)
- D = Drain
- EI = Electrical inlet (power)
- HWI = Hot water inlet

Top

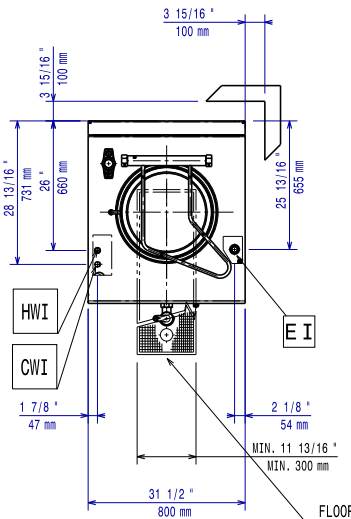

Electric

Supply voltage:	400 V/3N ph/50-60 Hz
Predisposed for:	
Total Watts:	9.4 kW

Key Information:

No clearance needed on rear sides of unit if wall is of non combustible type. If wall is combustible, minimum 50 mm wall clearance should be maintained.

Pan useful capacity:	60 lt
Vessel (round) diameter:	420 mm
Net weight:	115 kg
Shipping weight:	103 kg
Shipping height:	1200 mm
Shipping width:	1140 mm
Shipping depth:	870 mm
Shipping volume:	1.19 m ³
Certification group:	EBPI96M